



Application Note

AN2001

Numeric digital display 500213

DLS / FLS

Abstract

This application shows how to display a measured distance value on a standard external numeric digital display. Description of the wiring and sensor configuration are included as well as two samples are given.

V1.01

Please check www.dimetix.com
for the latest version

This application note is provided as is without any warranty for any problems this sample may cause.



Table of Contents

1 Introduction.....	3
1.1 Requirements.....	3
2 Validation.....	3
3 Wiring.....	3
4 Sensor configuration.....	3
5 Simple application example 1.....	4
5.1 Output protocol configuration.....	4
5.2 Measurements configuration.....	4
6 Advanced application example 2.....	5
6.1 Output protocol configuration.....	5
6.2 Gain and offset configuration.....	6
6.3 Measurements configuration.....	6



1 Introduction

With the appropriate configuration of Dimetix sensors, numeric displays can be connected directly to the sensor without the need of any additional controller. This application note shows how to connect such a display and describes the required configuration steps. Two examples are provided as well.

1.1 Requirements

A computer with an RS-232 Interface and our free "DLS_FLS Utility" Software installed.

2 Validation

This application note is valid for the DLS-B, DLS-C, FLS-C or newer sensors. It is not valid for the DLS-A or the EDS-C.

3 Wiring

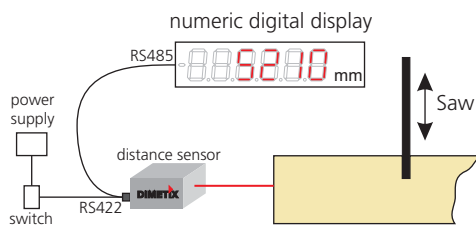

Fig. 1: Connection overview

Fig. 1 shows the connection of the components, while in Fig. 2 the detailed wiring diagram can be found.

Use a 6 pole shielded twisted pair cable to connect the display to the Sensor. 24V DC is used to power the display and the sensor. Take into account, that there is a significant voltage drop over the cable if the cable is long and the cross section is small.

The digital input DI1 (DO1 Pin) is connected to 24V DC via a 1k resistor. This signal ensures the start of the measurement as soon as power is applied. Measurement results are transmitted from the sensor to the numeric display.

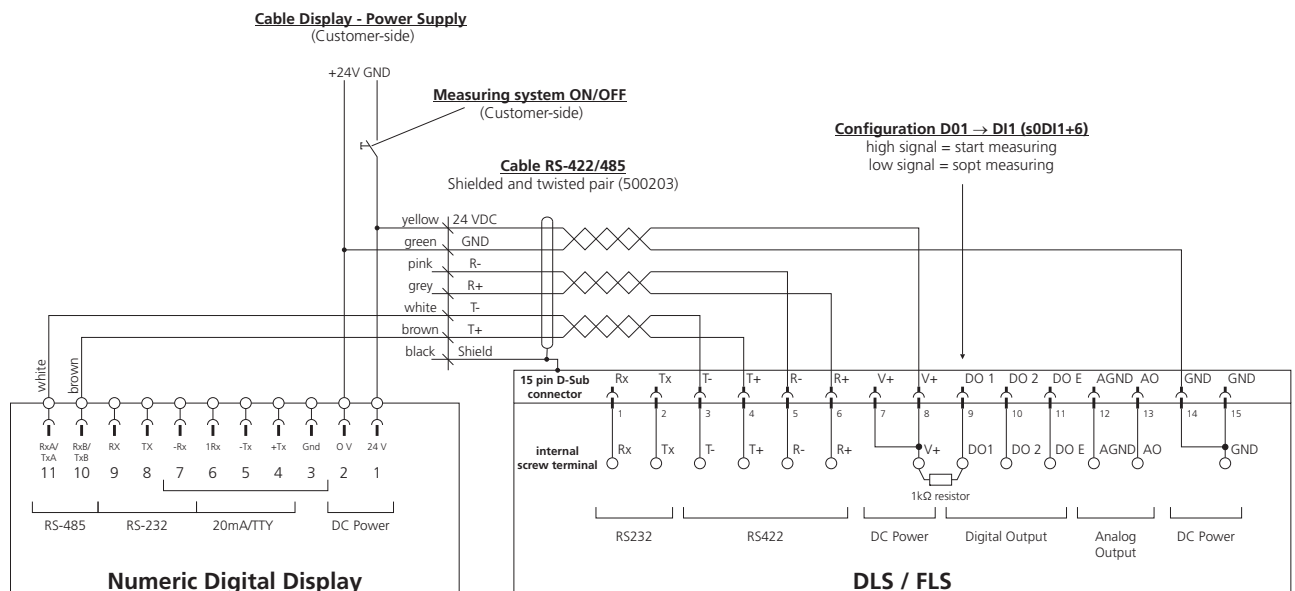

Fig. 2: Wiring diagram

4 Sensor configuration

The easiest way for an application specific sensor setting is to use our free "DLS_FLS Utility" software. The download is provided on our web page http://www.dimetix.com/support/EN_FRMSupportUtilitySW.html . Connect the sensor to the RS-232 interface of the PC as described in the sensor manual.



5 Simple application example 1

This is a simple application that directly shows the measured distance on the numeric digital display. No calculation with the measurement value are done before displaying it.

5.1 Output protocol configuration

This configures the displayed unit and the precision. In this sample the value is displayed in cm with a precision of mm.

Do the following steps with the DLS/FLS Utility SW

1. 'Connection' / 'Check Connection Button'
2. 'Configuration' / 'User output protocol' / Define the displayed value and the precision
3. Press 'DOWNLOAD TO DEVICE' the configuration is stored into the device

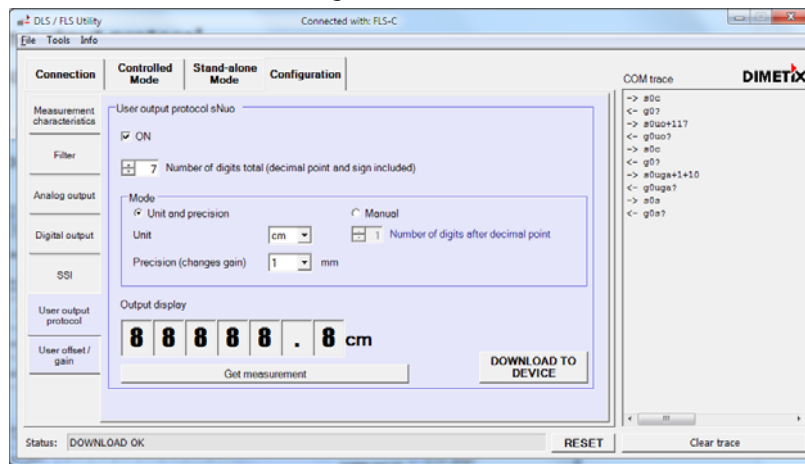

5.2 Measurements configuration

Activates the digital input and configures it for auto start measurement after a power-on of the sensor.

Do the following steps with the DLS/FLS Utility SW

1. 'Stand-alone Mode' / 'Manual start configuration'
2. Select 'Active' and 'Start / Stop Single Sensor user tracking'
3. Press 'DOWNLOAD TO DEVICE' the configuration is stored into the device

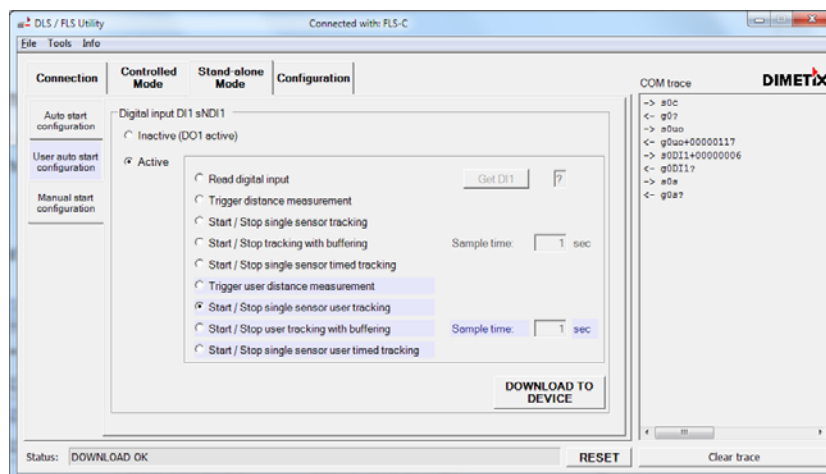

4. Do a power cycle on the sensor (Power off and on) and the system is running.



6 Advanced application example 2

Elements of different length must be cut by a saw. This application shows how to use the DLS/FLS sensor together with an external display to show the millimeter precise length of the piece before it get cut. Since the length of the cut-off piece can not be measured directly, some calculation have to be carried out before the length can be displayed. The DLS/FLS sensor is able to do this calculations, hence no additional controller is necessary. This sample shows the necessary steps to configure the sensor.

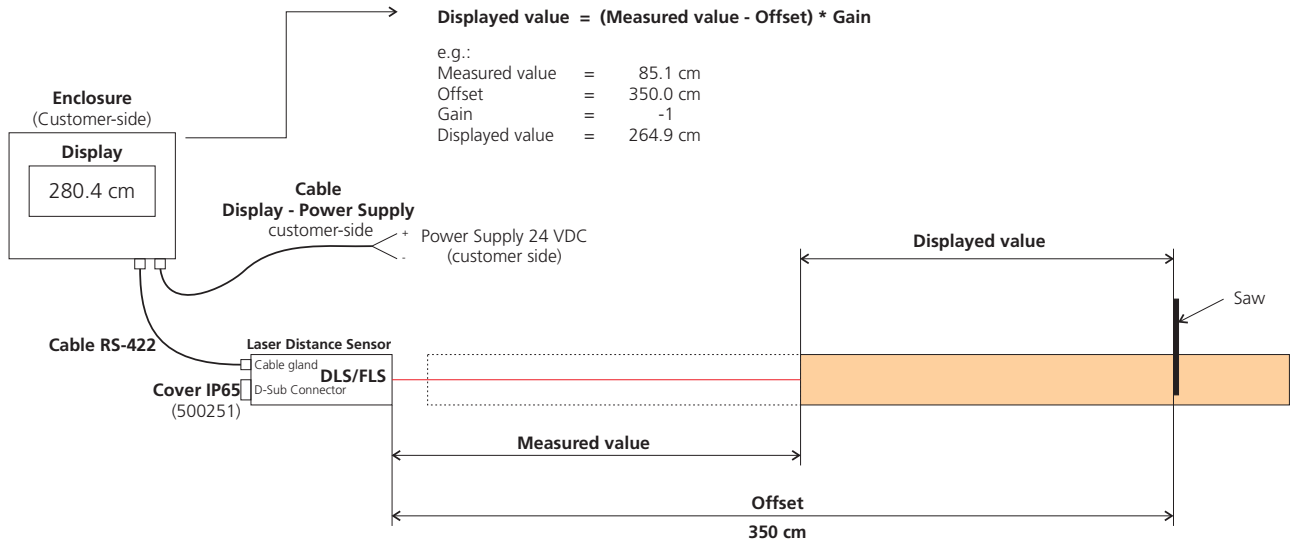

Fig. 3: Overview example 2

6.1 Output protocol configuration

This configures the displayed unit and the precision. In this sample the value is displayed in cm with a precision of mm.

Do the following steps with the DLS/FLS Utility SW

1. 'Connection' / 'Check Connection Button'
2. 'Configuration' / 'User output protocol' / Define the displayed value and the precision
3. Press 'DOWNLOAD TO DEVICE' the configuration is stored into the device

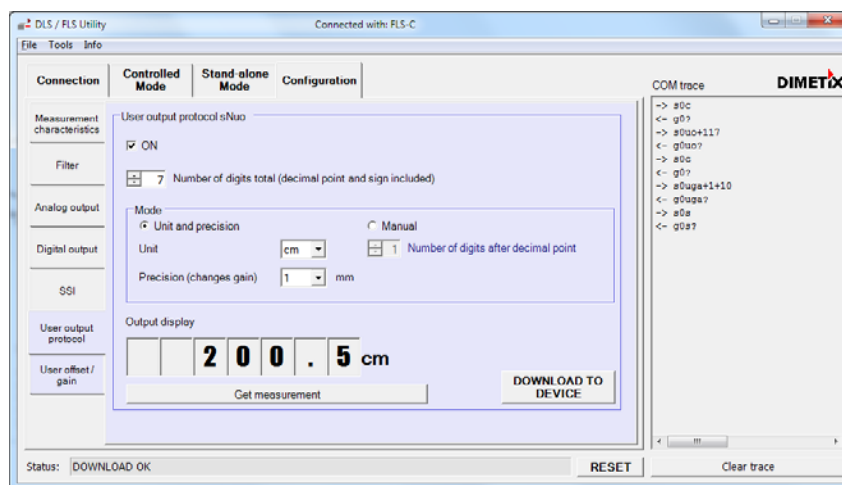



6.2 Gain and offset configuration

For this example gain and offset must be configured.

Do the following steps with the DLS/FLS Utility SW

1. 'Configuration' / 'User offset / gain'; Set the offset and the gain

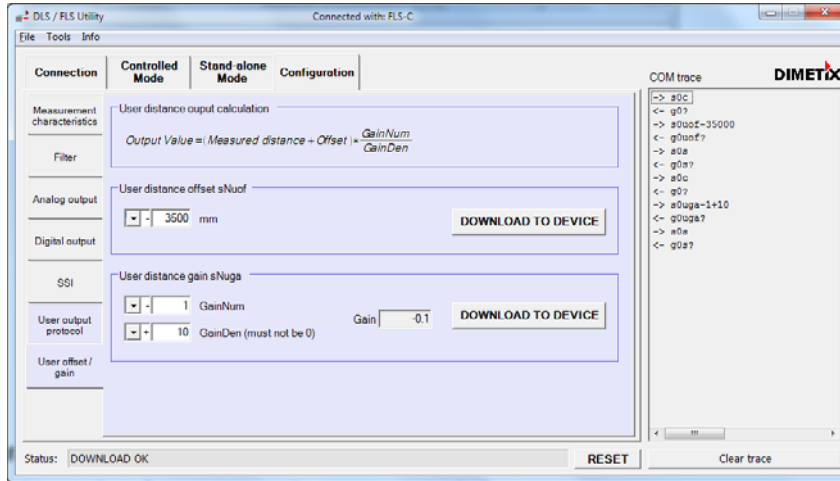

6.3 Measurements configuration

Activates the digital input and configures it for auto start measurement after a power-on of the sensor.

Do the following steps with the DLS/FLS Utility SW

1. 'Stand-alone Mode' / 'Manual start configuration'
2. Select 'Active' and 'Start / Stop Single Sensor user tracking'
3. Press 'DOWNLOAD TO DEVICE' the configuration is stored into the device

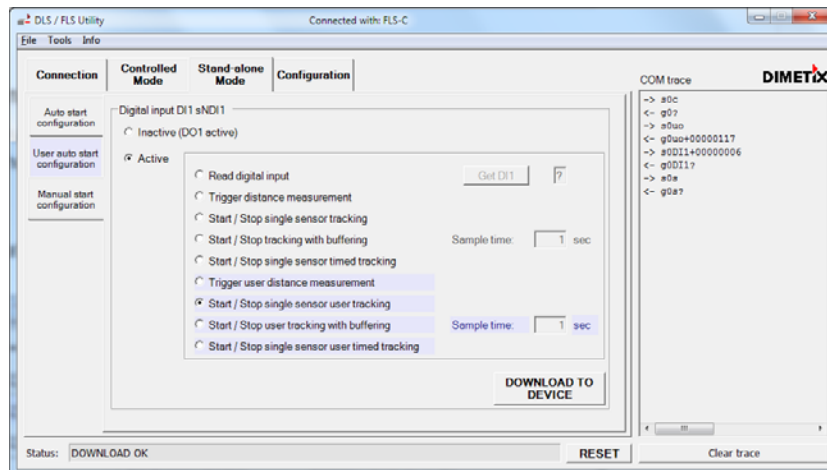

4. Do a power cycle on the sensor (Power off and on) and the system is running.